



*Autorità per l'energia elettrica e il gas*

**REPORT ON THE EVENTS OF SEPTEMBER 28<sup>TH</sup>, 2003  
CULMINATING IN THE SEPARATION OF THE ITALIAN POWER  
SYSTEM FROM THE OTHER UCTE NETWORKS**

*April 22<sup>nd</sup>, 2004*

### General introduction

*The present report deals with the events which occurred on the interconnected transmission grids of continental Europe in the night of September 28<sup>th</sup>, 2003. These events led to a complete electrical separation of the Italian power system from other UCTE networks. Following the separation, the Italian system suffered an almost complete black-out.*

*The results and the conclusions of this report are derived from the investigation carried out jointly by the Autorità per l'energia elettrica e il gas (AEEG: Italian regulatory authority for electricity and gas) and the Commission de régulation de l'énergie (CRE: French regulatory authority for energy). The joint investigation was established following Order no. 112/03 issued by AEEG on September 29<sup>th</sup>, 2003 and the joint communications issued by AEEG and CRE on October 6<sup>th</sup> and, subsequently, December 1<sup>st</sup>, 2003.*

*The information used for the joint investigation have been independently recovered by AEEG and CRE via direct requests to the TSOs concerned, according to the respective Italian and French jurisdictions, and by collecting documents in the public domain.*

*The investigation was carried out with technical support from experts from Supélec (Service électrotechnique et électronique industrielle) and Politecnico di Milano (Dipartimento di Elettrotecnica). The views expressed in this report are solely those of AEEG and CRE.*

<b>EXECUTIVE SUMMARY</b> .....	4
<b>CHAPTER 1 BACKGROUND</b> .....	5
<b>CHAPTER 2 CONCLUSIONS</b> .....	7
<b>TECHNICAL ANALYSIS</b> .....	11
<b>CHAPTER 1 CURRENT SET OF RULES AND PROCEDURES FOR SECURING OPERATION OF THE INTERCONNECTED POWER SYSTEMS</b> .....	12
<a href="#">1. N-1 Security criterion</a>	
<a href="#">2. Rules applicable to the events of September 28th</a>	
<a href="#">3. N-1 security criterion according to the UCTE rules</a>	
<a href="#">4. Additional procedure regarding the real-time operation of the grid interconnecting Italy, France and Switzerland (tri-lateral procedure)</a>	
<a href="#">5. Day-Ahead-Congestion-Forecast procedure (DACF)</a>	
<a href="#">6. Yearly Total Transfer Capacity (TTC) and Net Transfer Capacity (NTC) evaluation</a>	
<a href="#">7. Frequency Control in the UCTE</a>	
<a href="#">8. Maximum current on overhead lines and tree trimming practices</a>	
<b>CHAPTER 2 ANALYSIS OF PLANNED AND REAL OPERATION</b> .....	23
<b>A. Day-ahead security assessment and operational planning</b> .....	24
<a href="#">1. Lukmanier line reclosure</a>	
<a href="#">2. Use of external resources</a>	
<a href="#">3. Similarities between the contingencies of September 28<sup>th</sup>, 2003 and those of September 8<sup>th</sup>, 2000</a>	
<b>B. State of the interconnected grids at 03:00</b> .....	27
<a href="#">1. State of the Italian transmission grid</a>	
<a href="#">2. State of the French transmission grid</a>	
<a href="#">3. State of the Swiss transmission grid</a>	
<a href="#">4. Commercial cross border transactions</a>	
<a href="#">5. Physical and commercial flows</a>	
<b>C. Real time operation</b> .....	31
<a href="#">1. Coherence of the status of the Italian power system with the forecast scenario for the night of September 28<sup>th</sup></a>	
<a href="#">2. Coherence of the Italian import with GRTN forecast scenario for the night of September 28<sup>th</sup></a>	
<a href="#">3. Real time reaction of GRTN and RTE after the loss of the Lukmanier line (first trip)</a>	
<a href="#">4. Restoring secure operation after the loss of the Lukmanier line (first trip)</a>	
<a href="#">5. Real time compliance with the UCTE rules and the tri-lateral procedure</a>	
<b>D. Separation of the Italian power system from the UCTE network</b> .....	37
<b>CHAPTER 3 RECOMMENDATIONS</b> .....	38
<b>CHAPTER 4 APPENDIX</b> .....	39
<a href="#">1. Sequence of network events which occurred on September 28<sup>th</sup></a>	
<a href="#">2. Source of data</a>	

**REPORT ON THE EVENTS OF SEPTEMBER 28<sup>TH</sup>, 2003  
CULMINATING IN THE SEPARATION OF THE ITALIAN POWER  
SYSTEM FROM THE OTHER UCTE NETWORKS**

**EXECUTIVE SUMMARY**

## CHAPTER 1 BACKGROUND

During the night of September 28<sup>th</sup>, 2003 the European interconnected electrical system faced a series of disruptions, which started with line flashovers to trees and line trips on the Swiss extra high voltage (EHV) electricity transmission grids and ended with the separation of the entire Italian peninsula from the UCTE<sup>1</sup> network. Following the separation, the Italian electrical system (and part of the Swiss system, in the Ticino area), suffered an almost complete black-out.

In order to investigate the reasons and attribute responsibility for the events of September 28<sup>th</sup>, *Autorità per l'energia elettrica e il gas* (the Italian regulatory authority for electricity and gas, hereafter: AEEG), launched an inquiry into the events, based on its Order no. 112/2003 of September 29<sup>th</sup>. This Order notably stipulated that the inquiry into the events leading to separation of the Italian electrical system from the European network should be carried out in co-operation with the authorities responsible for regulating the electricity sectors in the relevant neighbouring countries.

On October 6<sup>th</sup>, AEEG, *Commission de régulation de l'énergie* (the French regulatory authority for energy, hereafter: CRE), and *Office fédéral de l'énergie* (the Swiss federal office for energy, hereafter: SFOE) decided to carry out a joint independent investigation into the behaviour of the interconnected power systems, in order to gain a better understanding of the events leading to the separation of the Italian electrical system from the European network and to draw conclusions.

The joint investigation began on October 15<sup>th</sup>, when AEEG, CRE and SFOE jointly agreed on a questionnaire to be sent to the Transmission System Operators (TSOs) concerned. The questionnaire was intended to gather information on the interpretation and application of UCTE recommendations on planning and operation security, the behaviour of the electrical power system during the events and the type and quality of information exchanged among the parties concerned (TSOs and Swiss electric utilities), both before and during the events.

Subsequently, SFOE failed to deliver any information, either written or verbal, and proposed adopting the UCTE interim report, issued by UCTE on October 27<sup>th</sup>, as the sole source of information for the investigation concerning the Swiss transmission grids. Furthermore, SFOE required the French and Italian TSOs and the integrated Swiss electricity companies to take part in the inquiry. AEEG and CRE could therefore not agree on the organisation of the investigation proposed by SFOE: they believed that the aforementioned participation was not compatible with the necessary independence of their inquiry. Moreover, on November 20<sup>th</sup>, SFOE independently and unilaterally issued a *Report on the black-out in Italy on September 28<sup>th</sup> 2003 [13]*, without previously consulting AEEG and CRE.

Following the afore mentioned unilateral position AEEG and CRE therefore decided to continue the investigation without SFOE and, in a letter dated December 1<sup>st</sup>, signed by respective Directors of AEEG and CRE, invited the integrated Swiss electricity companies directly to provide the same information already requested and obtained from the Italian and French TSOs.

---

<sup>1</sup> UCTE is the Union for the Co-ordination of Transmission of Electricity

In a letter from Swiss Electric<sup>2</sup> dated December 23<sup>rd</sup>, the integrated Swiss electricity companies refused to submit information to the regulators' enquiry and stated that all relevant information had already been released for other investigations (e.g., UCTE investigation, SFOE investigation and Italian Government investigation).

In spite of the absence of data from the Swiss parties, the amount and quality of information gathered from the Italian and French TSOs however enabled AEEG and CRE to reach a good and fair understanding of the events and the operational procedures jointly adopted by all the system operators<sup>3</sup> involved. The information retrieved by AEEG and CRE also provided a mean of assessing the application and implementation of the aforesaid operational procedures during the night of September 28<sup>th</sup>.

AEEG and CRE decided to proceed with the inquiry, with technical assistance from experts from Politecnico di Milano (Dipartimento di Elettrotecnica)<sup>4</sup> and Supélec<sup>5</sup>.

This report is only a part of a wider report that also assesses the series of events occurred in Italy after its separation from the UCTE networks, which is currently being drawn up by AEEG according to AEEG Order no. 112/03.

---

<sup>2</sup> Swiss Electric is the organization of Swiss electricity grid companies. Founded in April 2002, its members comprise ATEL, BKW, CKW, EGL, EOS and NOK. <http://www.swisselectric.ch/>

<sup>3</sup> The conclusions of this report are solely those of AEEG and CRE.

<sup>4</sup> <http://www.etic.polimi.it/>

<sup>5</sup> <http://www.supelec.fr/>

## CHAPTER 2 CONCLUSIONS

- 1. Before and during the night of September 27-28<sup>th</sup>, the Swiss transmission grids lacked sufficient prevention and preparation measures, to an extent that endangered the security of grid operation and supply across other power systems in Europe.**

According to the operation rules of the Swiss transmission grids, the lines were designed according to a standard operating temperature of 40°C. During the night of September 27-28<sup>th</sup>, the EHV lines of the Swiss transmission grids were operated at a much higher temperature: in this situation, it is still possible to operate the system under secure conditions with respect to the risk of tree flash over, but the insulation distance needs to be re-calculated and assessed to avoid increasing the risk of tree flash over.

The analysis of the events which occurred during the night of September 27-28<sup>th</sup> also shows that the phase angle difference which appeared between the ends of the Lukmanier line after its trip (and which prevented its reclosure) was totally predictable and should have been taken into account in the day ahead security assessment. However, no appropriate countermeasure (either inside or outside Switzerland) had apparently been prepared and secured by the Swiss electricity companies.

This demonstrates that, on September 28<sup>th</sup>, the Swiss transmission grids lacked sufficient prevention and preparation measures. This also constitutes a breach of the UCTE rules, which obviously severely jeopardised the security of grid operation and supply in Europe.

- 2. The integrated Swiss electricity companies did not comply with the UCTE rules during the night of September 28<sup>th</sup>.**

Among the UCTE rules, the N-1 rule is considered to be one of the most important prerequisites for secure operation of the interconnected transmission grids. In the specific case of system operation during the night of September 28<sup>th</sup>, the UCTE interim report [12] concludes that the N-1 rule was fulfilled “*taking into account countermeasures available outside Switzerland*”. This interpretation neglects the requirement, explicitly mentioned in the UCTE rules [1], for the “*prior agreement*” of the relevant TSO(s) and the obvious need to ensure that such countermeasures will be available in real time. During the night of September 28<sup>th</sup>, this was not the case for the Swiss transmission grids. Indeed, GRTN<sup>6</sup> maintains that there was no agreement with the integrated Swiss electricity companies that the pumping stations in Italy would be operating at the required level and could be adjusted at their request. The integrated Swiss electricity companies have not provided any evidence that such an agreement existed.

- 3. UCTE rules shall be made more detailed. Compliance with them shall be made legally binding. Independent assessment and control shall be enforced.**

The diverging interpretations of system operators’ compliance with the UCTE rules during the night of September 28<sup>th</sup> demonstrate the need to revise the UCTE rules or to provide interpretations to ensure that all technical prescriptions and responsibilities are unambiguously defined and attributed.

Moreover, the UCTE rules are a gentlemen’s agreement and no independent party is formally responsible for verifying that the TSOs comply with them. Each TSO is responsible for meeting

---

<sup>6</sup> GRTN is *Gestore della rete di trasmissione nazionale Spa* – Italian independent transmission system operator

such recommendations. The events of September 28th, as well as the developments of the regulators' independent investigation, indicate that this lack of independent control is detrimental to the security of grid operation and electricity supply in Europe, especially in the case where there is interaction of liberalised systems with vertically integrated and un-regulated systems.

Checks and assessments are therefore required to ensure that the UCTE rules are properly implemented. This means that the content and form of the UCTE rules need to be adapted. Given the regulators' role in controlling access to interconnections and the technical conditions for access to the transmission grids, CRE and AEEG suggest that the regulators be made responsible, under suitable terms, for the aforementioned checks and assessments.

**4. During the night of September 27-28<sup>th</sup>, the operators of the Swiss transmission grids took inappropriate measures. These operational mistakes led to the loss of the Sils-Soazza 380 kV line, following the loss of the Mettlen-Lavorgo 380 kV line (Lukmanier line), and thus to a N-2 event, for which the interconnected grids were not prepared.**

The investigation shows that the state of the interconnected grids as well as the level of imports were normal before the loss of the Lukmanier line, and consistent with the forecast grid situation.

As far as the reaction of the system operators after the loss of the Lukmanier line is concerned, whatever the outcome of the dispute between GRTN and ETRANS<sup>7</sup> regarding the exact content of their telephone conversation at 03:10:47, the sequence of events published by UCTE [12] and confirmed by SFOE [13] indicates that the procedure of informing the neighbouring TSOs was excessively delayed and incorrectly applied by ETRANS.

The investigation also shows that the first measures taken by the integrated Swiss electricity companies (intended to re-close the Lukmanier line) were inappropriate and ineffective, and that they resulted in the loss of nine minutes. It also shows that the second measure taken by the integrated Swiss electricity companies (request to GRTN to reduce imports by 300 MW) was insufficient to restore the flow on the Sils-Soazza 380 kV line (San Bernardino line) to a secure level. None of these measures corresponds with the checklist which, according to UCTE [12], was available to the ETRANS operators<sup>8</sup>.

The operational decisions taken in real time by the integrated Swiss electricity companies were not in line with the UCTE rules [1], or with the tri-lateral procedure [20] agreed between GRTN, RTE<sup>9</sup> and ETRANS, or indeed with the countermeasures prepared in advance by the Swiss electricity companies, as described in the UCTE interim report. In fact, they were not sufficient to restore the interconnected transmission grids to a secure state. They were therefore the direct cause of the loss of the San Bernardino line. The loss of this line placed the interconnected transmission grids of UCTE in a N-2 state where, according to the UCTE rules, the security of grid operation is no longer assured.

---

<sup>7</sup> ETRANS is the independent system co-ordinator in the Swiss transmission grid

<sup>8</sup> According to UCTE [12], this check list “explicitly mentions that, in case of loss of the Mettlen-Lavorgo, the operator should call GRTN, inform GRTN about the loss of the line, request for the pumping to be shut down, generation to be increased in Italy”.

<sup>9</sup> RTE is *Gestionnaire du réseau de transport de l'électricité* – French independent transmission system operator



## **5. Co-ordination among TSOs shall be reinforced for operational planning and real time operation of the interconnected grids.**

The investigation's results demonstrate that neither the increase in cross border trade resulting from implementation of the European Union's directives, nor its variability, were the cause of the events which led to the separation of the Italian peninsula on September 28<sup>th</sup>, 2003. However, this variability requires adequate co-ordination procedures among the TSOs of the continental plate.

Such procedures will certainly not put an end to the discrepancy between scheduled commercial flows and physical flows at the electrical borders of each country. This discrepancy has always existed and will always exist, as it results from the laws of physics. Instead, the procedures should aim at ensuring that the physical transits which result from all commercial transactions on the continental plate, resulting from implementation of the internal electricity market, are under the TSOs' control. This requires multilateral agreements and procedures on capacity allocation, transaction nominations and grid operating conditions forecasts, such as those partially proposed by ETSO<sup>10</sup> in its co-ordinated congestion management project. CRE and AEEG stress that these co-ordination procedures will be more efficient if they rely on high quality input data. This can only be achieved if the effective independence of all the TSOs involved guarantees that the shared information remains confidential.

If appropriately designed, the co-ordination procedures will contribute to reducing operating costs and increasing cross border capacities, whilst maintaining an appropriate level of security. To this aim, they shall include the implementation of a common framework for exchanging balancing energy, which would enable the TSOs to share their reserves in real time and provide a framework for cross border contracting up or downward frequency regulation. It would therefore enable TSOs to rely on countermeasures available outside their control area for matching their own grid's security requirements.

## **6. A legal and regulatory framework coherent with EU legislation is necessary in Switzerland to ensure the security of grid operation and supply in Europe.**

The development of AEEG and CRE's expert studies demonstrates the importance of implementing a binding framework, requiring the integrated Swiss electricity companies to provide information, so that the secure operation of transmission grids can be assessed. Indeed, SFOE has not been in a position to provide the information, which it undertook to provide to the tri-lateral CRE-AEEG-SFOE inquiry task force. Later, the integrated Swiss electricity companies also refused to release the said information to the regulators' inquiry, considering that the UCTE interim report [12]<sup>11</sup> provides sufficient information and valid conclusions. AEEG and CRE therefore had to carry out their independent expertise based on data relating to the Italian and French transmission grids and on data relating to the Swiss transmission grids as published by UCTE and SFOE, although the events which led to the separation of the Italian Peninsula occurred on the Swiss transmission grids.

The events of September 28<sup>th</sup> also raise questions as to whether the security of grid operation can be maintained while Swiss electricity companies, which are still vertically integrated, are free to operate in the European Union's internal electricity market. Indeed, the integrated Swiss electricity companies can strongly influence the distribution of flows inside and outside their grids by topology choices and dispatching decisions. Depending on these operating decisions, which have different impacts on the security of grids, the transit through Switzerland and export capacity from Switzerland can be significantly modified.

---

<sup>10</sup> ETSO is the international association of the European transmission system operators

<sup>11</sup> The Swiss electricity companies were both investigated and investigating parties to this report.

Finally, the events of September 28<sup>th</sup>, raise questions over the quality and control of operating practices and grid maintenance in Switzerland, where there is no unbundled TSO. AEEG and CRE note that, in the absence of an adequate regulatory framework, there is an incentive for the electric companies to excessively load their lines, to deny redispatching measures and to reduce their operating costs at the expense of the security of their own system and of neighbouring systems. In the case of September 28<sup>th</sup>, two consecutive flashovers to trees in the Swiss transmission grids caused the separation of the Italian peninsula. Information on the operation and maintenance of the Swiss transmission grids, as published by UCTE [12] and by the Swiss administration [13], shows that the sag computation is carried out conventionally, assuming a conductor temperature of 40°C. According to the Swiss administration [8], the general practice in Switzerland consists of loading the lines heavily (and overloading them during short periods), thus leading to a conductor temperature well above 40°C. This implies that the permissible degree of conductor sag should be verified at least at critical points on the lines.

AEEG and CRE's independent investigation therefore demonstrates that it is crucial for the security of electricity supply in the European union that a legislative and regulatory framework should be implemented in Switzerland, coherently with European Union legislation. The future framework should consist of :

- the obligation, for the Swiss electricity companies, to unbundle grid operation from power production and trading, and establish a Transmission System Operator effectively independent from the Swiss electricity transmission operators, producers and suppliers and fully responsible for secure grid operation;
- the institution of a body empowered to access all the information required to monitor, control and assess the Swiss electricity companies' compliance with the security rules concerning the operation of transmission grids, and compliance with unbundling and third party access requirements.

**REPORT ON THE EVENTS OF SEPTEMBER 28<sup>TH</sup>, 2003  
CULMINATING IN THE SEPARATION OF THE ITALIAN POWER  
SYSTEM FROM THE OTHER UCTE NETWORKS**

**TECHNICAL ANALYSIS**

# CHAPTER 1

## CURRENT SET OF RULES AND PROCEDURES FOR SECURING OPERATION OF THE INTERCONNECTED POWER SYSTEMS

### **Outline**

- The rules and procedures adopted by the transmission system operators and electric utilities to ensure the secure operation of interconnected power systems, if properly interpreted and applied, would have been consistent with the aim of ensuring secure operation of the Italy-France-Switzerland interconnection in the context of the night of September 28<sup>th</sup>.
- The practice of the integrated Swiss electricity companies concerning tree trimming and maximum current on the transmission lines could not be assessed exhaustively, due to the refusal by these companies to provide CRE and AEEG with information. The practice observed during the night of September 28<sup>th</sup>, however, raises strong suspicions that the Swiss transmission grids are operated above their design values and that this endangers the security of electricity supply.
- A mandatory legal framework needs to be established at European level in order to ensure that all technical prescriptions and responsibilities are defined completely and unambiguously. This framework shall include an independent party formally responsible for verifying that TSOs comply with the mandatory prescriptions.
- In addition, a higher degree of co-ordination between TSOs shall be introduced in order to achieve a common procedure for day-ahead grid operation planning and acceptance of day-ahead nominations. This includes the definition of a common framework for assessing the influence of cross border nominations on the grids of the other TSOs, the implementation of common and complete load flows in day-ahead and of a framework for cross border balancing energy exchanges in real time, with the aim of increasing the security of operation through cross border redispatching.

### 1.1. N-1 Security criterion

Due to the unique features of electric power systems, the events occurring in interconnected power systems (such as the loss of a line) can spread to the entire interconnected transmission grid very quickly and lead to cascade events. Such events can lead to a deterioration in the operating condition of the networks causing, in the most serious cases, the loss of portions of the power system or even the loss of the entire power system.

This implies that adequate defensive strategies must be prepared, assuming that any network element has the possibility of tripping unexpectedly at any time. These considerations led to the worldwide adoption of the so-called “N-1 criterion”, which involves operating the system such that it remains under secure conditions, even when contingencies (pre-determined and one at a time) occur. Secure conditions refer to operating conditions where the load is satisfied without any constraint violations (current limits on lines and transformers, minimum and maximum voltages at busses, etc.).

The general framework for N-1 security criterion implementation can be represented in figure 1.1.

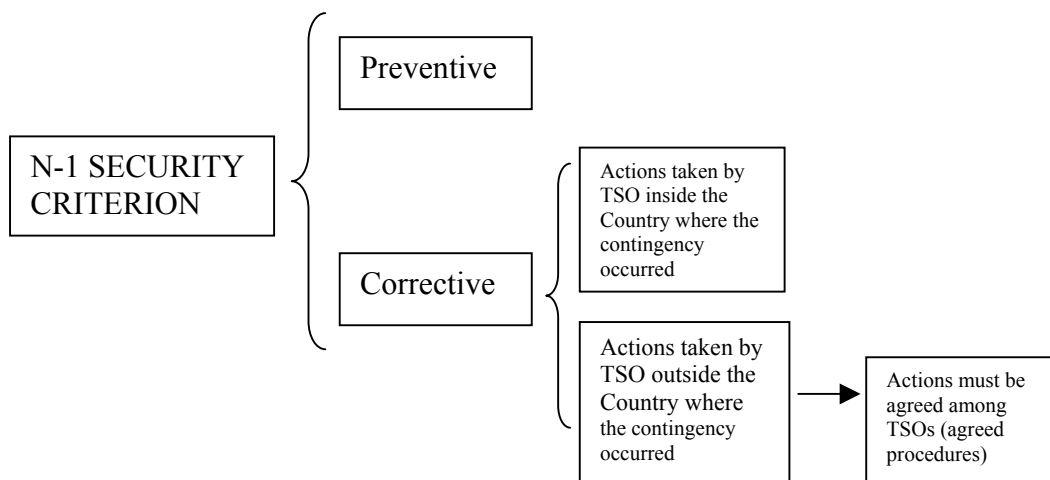

Figure 1.1 – N-1 security criterion general framework

This diagram shows that the N-1 security criterion can be implemented either in a preventive or in a corrective way. According to the *preventive* method, the system can face any credible contingency (loss of a single network element) whilst continuing to operate in a secure state (without any constraint violation) for an indefinite period, provided another contingency does not occur. The latter is commonly referenced to as N secure operating state. It is good practice (as is also stated in the UCTE rules [1]) to act to re-establish the N-1 secure state “*as soon as possible*”. According to the *corrective* method, some constraint violations are permitted following an initial credible contingency (N secure operating state not verified), provided the TSO acts to re-establish the N security condition within a period of time that is normally pre-determined (for instance, 20 minutes). Such actions must be specified in advance and properly prepared by the TSO (N-1 security with post-contingency control movements - [9], [10], [11] and [19]). Under both methods, after a contingency the TSO should re-establish the N-1 security state as quickly as possible.

In some power systems (for example NERC<sup>12</sup>, Nordel<sup>13</sup> and UCTE<sup>14</sup>), the above mentioned process led to the definition of a set of detailed rules. For example, in North America, NERC recently issued an operating manual [15] with a specific policy devoted to transmission operations (Policy 2A). In Nordel's system, these issues are addressed in the document on Reliability standards and system operating practices [16] where some detailed reliability criteria regarding the management of N-1 conditions have been addressed. In the UCTE system, this process led to the adoption of the so-called "UCTE rules" [1] in the non-binding form of recommendations, which, although they are not perfectly complete and detailed, adopt the corrective method.

### 1.2. Rules applicable to the events of September 28<sup>th</sup>

The events of September 28<sup>th</sup>, which led to the separation of the Italian power system from the UCTE network, mainly concerned the Italian, French and Swiss interconnected networks. For these interconnected systems the following rules on secure operation of networks apply :

- the UCTE security and reliability standards that are expressed by a set of recommendations (UCTE rules [1]) agreed by all TSOs and electric utilities; UCTE rules are not mandatory guidelines: under these recommendations, each national framework for planning, constructing and operating the transmission grids shall voluntarily enforce the UCTE rules;
- the *tri-lateral procedure* [20], implemented in 2001 by common agreement between the system operators in Italy, France and Switzerland for the secure operation of the network interconnecting the three countries;
- the Day Ahead Congestion Forecast (DACF) procedure implemented by most of the members of UCTE, including the Italian, French system operators and Swiss utilities.

Other rules and procedures applicable to secure the operation of interconnected power systems concern the calculation of the total transfer capacity (TTC) and the definition of the transmission reliability margin (TRM), the conditions for controlling planned energy exchanges between countries and maintenance practices for overhead lines.

### 1.3. N-1 security criterion according to the UCTE rules

The definition of the N-1 security criterion is given in the *Summary of the current operating principles of the UCPTE*<sup>15</sup> [1], approved by the UCPTE steering committee in 1998. According to this document, "*under all operating conditions, the loss of any given element (line, transformer, generating unit, compensation facility etc.) will not lead to operating constraints in adjoining operating zones (as a result of limit values being exceeded for current, voltage, stability, etc.) and, by the same token, will not cause interruptions in supply. Although, under these conditions, it will not be necessary to interrupt network operation as a result of the loss of one element, the structure of the system concerned will need to be reorganised in order to comply again with the N-1 criterion within the shortest possible time. In the intervening time, the loss of a further element might indeed jeopardise continuity of operation*".

---

<sup>12</sup> NERC is the North American Electric Reliability Council. Its mission is to ensure that the bulk electric system in North America is reliable, adequate and secure. <http://www.nerc.com/>

<sup>13</sup> Nordel is a body for co-operation between the transmission system operators (TSOs) in the Nordic countries (Denmark, Finland, Iceland, Norway and Sweden), whose primary objective is to create the conditions for, and to develop further, an efficient and harmonised Nordic electricity market. <http://www.nordel.org/>

<sup>14</sup> UCTE is the Union pour la Coordination du Transport de l'Electricité. It is the association of transmission system operators in continental Europe, providing a reliable market base by efficient and secure electric "power highways". <http://www.ucte.org/>

<sup>15</sup> UCPTE used to be Union pour la Coordination de la Production et du Transport de l'Electricité, nowadays UCTE.

This document also states that *“the N-1 criterion may be kept with the support of a neighbouring system, subject to the prior agreement of the latter. This presupposes that scheduled outages for the performance of work affecting adjoining systems have been agreed beforehand by the members concerned [...] and that these members will exchange all the information and data required for the completion of real time and forecast calculations for network security”*.

As far as the operation of interconnections is concerned, the *Summary of the current operating principles of the UCPTE* [1] also specifies that *“the entire network, including cross-border tie-lines, must be operated in such a way that sufficient transmission capacity will be available for the delivery of reserve primary control power to the areas which may be affected by an incident.”* In addition, the *Measures to counteract major disruptions in interconnected operation and to re-establish normal operating conditions* [2], approved in 1991, state that *“the necessary measures must be taken in the internal network to ensure that there are no bottlenecks liable to adversely affect interconnected operation”*.

The *Measures to counteract major disruptions in interconnected operation and to re-establish normal operating conditions* [2] define the actions to be taken in case of contingency. *“As overload situations can occur here, it is important that the load dispatching system has the facility to promptly reduce the overload, either by running up or calling on reserve generating capacity, or by changing the distribution conditions in the network, without however interrupting the power supply”*. *“If a situation arises in the network of a partner which could endanger the reliability of the internal or international transmission, the partner must inform the other partners concerned without delay”*. *“Based on the results of fault analyses and network reliability calculations, suitable remedial measures to prevent major disruptions must be agreed between the partners. System faults must therefore be analysed systematically. It is recommended that these analyses are not limited to the interconnecting lines to the neighbouring networks, but are expanded to cover the complete network consortium affected by the fault, taking into account the various possible combinations”*.

It therefore results from the UCTE rules that following a disturbance, the TSO of the country where the disturbance occurred, must act to reschedule generation or to modify network topology, in principle within its own internal system, without load shedding. A TSO can however adopt corrective actions relying on other countries' resources, provided such actions have previously been agreed between the TSOs and the appropriate and preventive information process is implemented.

Under the corrective approach to the N-1 security criterion, in addition to corrective actions, proper scheduled operating procedures (including information exchange procedures) should be prepared.

Compared to the definitions of the N-1 criteria adopted by other associations, the UCTE rules do not specify the maximum time interval for corrective measures to be implemented. Indeed, they state that the N-1 operating conditions must be restored as soon as possible. For security reasons, the overload period shall however not be longer than the maximum permissible duration of overload for lines and transformers, which, normally, is assumed to be 20 minutes, as it is the case in Italy and France.

On the contrary, the other associations are much more detailed: they impose a maximum period within which N security conditions must be restored. For example, NERC states that *“Following a contingency or other event that results in an operating security limit violation, the control area shall return its transmission system to within operating security limits as soon as possible, but no longer than 30 minutes”*[15], while Nordel [16] states that *“Following a disturbance on the N-1 level, the system shall within 15 minutes resume operation within normal limits of transmission capacity and frequency deviation.”*

Finally, the UCTE rules lack a clear definition of the management of countermeasures to be adopted in the event of a threat to the secure operation of interconnections. Moreover, in such cases, the process to be followed when exchanging relevant information is not clearly defined.

UCTE rules, in defining N-1 security criterion:

- give the prescription to re-establish the N-1 secure state as soon as possible;
- do not define clearly what information should be exchanged, the preferred method of exchange (fax, recorded phone call, etc.) and the relevant time constraints.

#### 1.4. Additional procedure regarding the real-time operation of the grid interconnecting Italy, France and Switzerland (tri-lateral procedure)

The Italian, French and Swiss TSOs agreed on a procedure (*Procédure d'urgence Suisse-Italie-France* [20] or tri-lateral procedure) to be followed in the event of a technical constraint being breached on a line close to a border, which could result in insecure operating conditions for the systems managed by the same TSOs. This procedure is intended as a response to emergency situations, defined as follows: *“On considère que la situation est tendue dans un pays lorsque les règles de sûreté en N ou N-k ne sont pas respectées, et ce, malgré la sollicitation de tous les moyens (topologie et plan de production) susceptibles de résoudre la contrainte”*. It shall therefore not be considered by the TSOs as a regular countermeasure, when dealing with operational planning or day ahead schedules.

In particular, the tri-lateral procedure establishes the following process :

- *“Un des GRT a détecté une situation tendue sur son territoire, et en a informé les 2 GRT voisins par l'envoi d'un fax d'information”;*
- *“Chacun des GRT voisins étudie alors l'impact sur son territoire des conséquences potentielles liées à la contrainte détectée. ... Si cet impact génère sur son territoire un non-respect des règles de sûreté, il en informe les deux GRT voisins, en précisant le critère à atteindre pour retrouver un domaine de sûreté (transit maximal aux frontières)”;*
- *“Une action est à engager si le non-respect des règles de sûreté dans un des pays entraîne une situation non maîtrisée dans un pays voisin. On compare alors les transits aux frontières avec les transits commerciaux: la priorité est donnée aux changements de topologie et aux aménagements de production dans chacun des pays concernés, afin de se rapprocher des transits commerciaux. Chaque GRT s'engage à mettre en œuvre les changements de topologie et les aménagements de production nécessaires pour retrouver une situation dans laquelle le non-respect des règles de sûreté dans un des pays n'entraîne aucune conséquence, ou des conséquences maîtrisées par des parades, dans les autres pays”*.

According to the tri-lateral procedure, each TSO must study the effects of contingencies occurring in its own system and concerning the Italian, French and Swiss interconnected systems.

Whenever a contingency threatening security occurs, the TSO concerned must:

- promptly inform the other two TSOs by sending a fax so that the neighbouring operators can study the impact of the disruption on their systems;
- take necessary corrective actions inside its own system, in co-ordination with the measures taken by the neighbouring TSOs.



The tri-lateral procedure completes, at least for the real-time operation of the Italy-France-Switzerland interconnecting grid, the outline on transmission security set out by the UCTE rules. It establishes additional rules regarding co-ordination between TSOs, for managing particular conditions that are considered dangerous with respect to the secure operation of the interconnected power systems.

The set of UCTE rules and tri-lateral procedure, if properly interpreted and applied, would have been consistent with the aim of ensuring the secure operation of the Italy-France-Switzerland interconnection in the context of the night of September 28<sup>th</sup>.

#### 1.5. Day-Ahead-Congestion-Forecast procedure (DACF)

The goal of the DACF procedure is to inform all the TSOs involved about the state of the other members' grids (topology, injections and loads, etc.) so that they can compute the physical flows corresponding to the commercial nominations and to the topology and injection pattern planned in the day ahead. This aims at ensuring more effectively that each area of the UCTE system is operated according to the security criteria.

The DACF procedure establishes that, at predefined time intervals, detailed information on the forecast scenarios (typical peak and off peak hours) for the transmission systems of each UCTE country are exchanged between TSOs. The information exchanged allows each TSO to investigate the physical state of its own network (running a power flow study), including the state of the interconnection. The main principles on which the DACF procedure is based are obligation and reciprocity. Indeed, each country must provide all other countries with a complete set of forecast load-flow data for its grid, and each TSO can obtain the data from other TSOs only if it agrees to provide the same type of information (in terms of quality and scenarios) to all the UCTE TSOs.

On September 27<sup>th</sup>, the DACF procedure operated only to a certain extent [22]. In particular, for Italy, Switzerland and France, according to the agreed procedure, data were posted on a daily basis (daily posting of information) with reference to the 10:30 scenario and on a weekly basis (weekly posting of information) with reference to the 03:30 scenario. At that time, according to GRTN, it also elaborated daily 03:30 forecast scenarios and posted them on the DACF data base.

On September 28<sup>th</sup>, thanks to the DACF procedure, each TSO was in a position to:

- retrieve data sent by each TSO on its grid's topology and on the availability of transmission lines and generation units ;
- run security calculations on its own network, adopting at least a proper equivalent for foreign countries;
- check that these calculations were consistent with the data posted by other TSOs.

#### 1.6. Yearly Total Transfer Capacity (TTC) and Net Transfer Capacity (NTC) evaluation

On a yearly basis, the TSOs of Italy, France, Austria and Slovenia, along with the integrated Swiss electricity companies, jointly carry out studies in order to establish the maximum transfer capacities available to import electric energy into Italy, whilst preserving the secure operation of the overall interconnection. These transfer capacities are differentiated between summer and winter, as the lower ambient temperature in winter enables the lines to carry higher flows than in summer.

For September 28<sup>th</sup>, 2003, the values of NTC agreed for each electrical border of Northern Italy [4], [5], [6], [7] and [21] were the following:

- France – Italy: 2400 MW (summer<sup>16</sup> value), raised by common agreement<sup>17</sup> to 2650 MW (winter<sup>18</sup> value);
- Switzerland – Italy: 2500 MW (summer value), raised by the same agreement to 3050 MW (winter value) ;
- Austria – Italy: 200 MW (summer value), raised by the same agreement to 220 MW (winter value);
- Slovenia – Italy: 300 MW (summer value), raised by the same agreement to 380 MW (winter value) and additional not firm capacity of 100 MW.

This leads to a total NTC of 6300 MW (increased to 6400 MW when taking into account the not firm assignable capacity right on the border between Italy and Slovenia), which, considering a TRM of 500 MW, corresponds to a TTC of 6800 MW (increased to 6900 MW when taking into account the above mentioned not firm assignable capacity right).

The TRM (namely, the Transmission Reliability Margin (TRM) equal to 500 MW, constant during the year) copes, according to ETSO “with uncertainties on the computed TTC values arising from:

- *unintended deviations of physical flows during operation due to the physical functioning of load-frequency regulation (see paragraph 1.7),*
- *emergency exchanges between TSOs to cope with unexpected unbalanced situations in real time,*
- *inaccuracies, e. g. in data collection and measurements”.*

The above TTC and NTC figures for September 2003 on Italy’s Northern border were commonly agreed by all the TSOs involved. They include a Transmission Reliability Margin of 500 MW, not allocated for commercial transactions and intended to cope with the usual and unavoidable fluctuations of physical exchanges in real time.

### 1.7. Frequency Control in the UCTE

Since there is no practical way of storing electrical energy, load and generation must be balanced in real-time. Even if load forecast studies ensure a rough balance on a day-ahead basis, small variations in production must be controlled in real-time, in order to deal with forecast errors or with generation hazards. This is the aim of automatic frequency control in the UCTE system [3], which is characterized by two hierarchical levels:

#### 1.7.1 *Primary frequency control*

The goal of primary frequency control is to modify very quickly the power of generators, in order to follow load variations in real-time. The main difficulty lies in sharing the generation control between numerous generators, all connected to the UCTE network. Actually, in the event of a disruption in load or generation, a steady state is reached around ten seconds after the event. The steady state is characterised by a frequency slightly different from the rated value and a variation of

---

<sup>16</sup> Summer period are the months from May to September with exception of August for which different figures are defined.

<sup>17</sup> As published by GRTN on its website on September 24<sup>th</sup>, 2003.

<sup>18</sup> Winter period are the months from October to March.

the power exchange between countries, because all the generators in the interconnected UCTE system participate in primary frequency control.

### 1.7.2 Secondary frequency control (also called f/P control)

Primary control is very rapid and limits the effects of unexpected load or generation variations, but it does not ensure a frequency value exactly equal to the rated value. Moreover, it does not preserve the scheduled exchanges between countries. The goals of secondary frequency control are thus to eliminate the frequency error inherent to primary frequency control and to bring power exchanges back to the scheduled programs.

Automatic secondary frequency control is much slower than primary frequency control. Typically the action of the f/p control lasts from 30 seconds to 15 minutes, compatible with the operation of thermal power plants. It is, in particular, able to control the exchanges of power among control areas (countries) in a time frame of several minutes.

It is therefore normal for unavoidable real time behaviour of the system (or for disruptions) to cause instantaneous deviations from the scheduled exchanges. In fact, due to the time constants of secondary frequency control, differences between the sum of actual power flows in the interconnection lines of a country and the sum of the scheduled power exchanges can often reach values up to 300 MW and even much more, positive or negative. Figure 1.2 shows an example (relevant to September 27<sup>th</sup>, 2003) of power difference between actual French exports and scheduled programs; figure 1.3 shows the same difference on the Northern border for the night of September 28<sup>th</sup>, 2003. Such differences are usually accepted and have to be considered in the security assessment by means of an adequate amount of power margins on the interconnections between Countries (TRM). Automatic f/P control corrects the above mentioned deviations in real-time in such a way that the mean value of the exchanges is equal to the program.

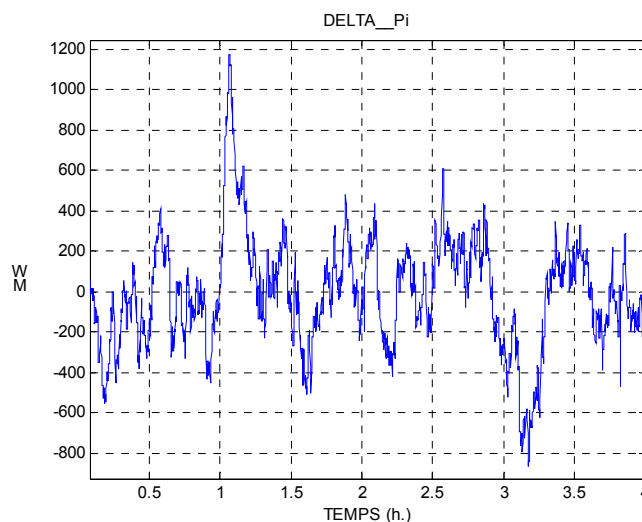

**Figure 1.2 : example of power difference at the frontiers of the French system between actual flows and scheduled ones between 27/09/03 (00:00) and 27/09/03 (04:00) (source : RTE)**

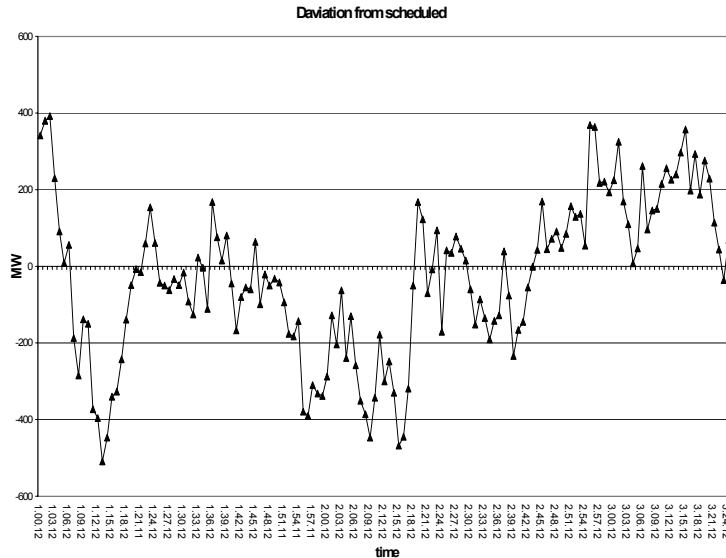

**Figure 1.3 : power difference at the Northern border of the Italian system between actual flows and scheduled ones between 28/09/03 (01:00) and 28/09/03 (03:24) (source : GRTN)**

It is absolutely normal and unavoidable to observe an instantaneous difference between scheduled programmes and actual imports or exports. This difference may reach several hundred MW for a country like France or Italy. Only a non-zero mean value on a significant time interval of this instantaneous difference would mean that the country in question is not exchanging energy with its neighbours according to the programmes.

### 1.8. Maximum current on overhead lines and tree trimming practices

When power flows in a transmission line, the current generates electric losses which increase the operating temperature of the line. Because of this thermal effect, the line sag increases and faults between conductors and the ground (or trees) are more likely to appear. The possibility of flashovers between conductors and trees is significantly limited if an adequate distance is considered when the line is designed and the same minimum distance is guaranteed by proper tree trimming practices. For security reasons, transmission lines must therefore be properly designed and maintained, and every line operated within its maximum capacity.

In practice, thermal effects being quite slow, it is possible to accept an overload current for a given period of time. Of course, the higher the current, the shorter the possible overload time interval. Above a given value of current, the tripping of the line has to be instantaneous. The definition of possible overload time intervals (typically between 5 minutes and 20 minutes) is very useful for system operators who can take advantage of these periods, to introduce a predetermined set of control actions for eliminating an overload.

The thermal effects due to an overload depend greatly on climatic conditions, and particularly on the ambient temperature. For this reason, the maximum capability of a line could be redefined in real-time, depending on the actual climatic conditions and subject to adequate tree trimming practices, as the permissible current is directly influenced by the distance between conductors and trees.

Of course, a real-time setting would mean that the system could be operated very close to its physical limits. Nevertheless, such a strategy is risky and difficult to implement. Current limits are therefore usually determined for long periods: for instance, a current limit per season. This practice, which forms part of a prudent approach to operating power systems, is widespread in Europe (see following table 1.1).

Country	Number of periods
Belgium	4
UK	5
France	5
Italy	2
Switzerland	not available
Scandinavia	2

**Table 1.1 : Periods used to calculate the current limits used by grid operators**

In France and Italy, the corresponding maximum capacities are also taken into account in day-ahead and real-time N-1 security studies and are used to define the transfer capacities available for cross border transactions.

Given that the integrated Swiss electricity companies refused to co-operate in the independent CRE/AEEG investigation, no information (besides the report [8] by the Federal Inspectorate for Heavy Current Installations, FIHCI) has been made available to the CRE/AEEG investigation regarding the methods used in Switzerland.

However, according to the legislation governing the construction and operation of electricity supply lines in Switzerland, as described by FIHCI [8], the maximum anticipated conductor sag is determined on the basis of a conductor temperature of 40°C. The Swiss legislation also authorizes operation of the lines above 40°C, up to 80°C according to the *Principes directeurs d'Electrosuisse* quoted by [8]. Thus, the minimum vertical distance between trees and uncovered conductors is not defined considering the actual operating conditions. FIHCI notes this discrepancy and concludes that an in-depth analysis is needed to assess “*whether the assumptions adopted in Article 47 of the Ordinance on Electricity Supply Lines for calculating the maximum anticipated degree of sag of a conductor are still correct*” : “*conductor temperatures need to be re-specified, and in the event that these should significantly exceed 40° C in normal operation, the permissible degree of sag at critical points will need to be re-assessed*”.

Indeed, although the transmission lines can be operated at temperatures above 40°C, clearances should never fall below a reasonable security threshold. TSOs should consider this when operating the systems, bearing in mind the characteristics of each system. In the case of the night of September 28<sup>th</sup>, at the time of the trip of the Lukmanier line (Mettlen-Lavorgo), the conductor temperature was 72°C<sup>19</sup> in the area of Ingenbohl where the first flashover took place. As a consequence, according to FIHCI, the sag of the line was 27,54 m, to be compared to a maximum sag of 25,90 m under the design conditions (40°C).

Furthermore, FIHCI states that the inspections of the 52-kilometer section between Mettlen and Amsteg of the Lukmanier line, which had been carried out between June 30<sup>th</sup> and July 11<sup>th</sup>, 2003 in order to check whether the vertical distances between trees and uncovered cables of overhead high-voltage lines met legal requirements, had highlighted that “*trees needed to be cut back or lopped at a variety of locations. This also applies to the section between pylons 9482 and 9483 affected by the*

<sup>19</sup> According to FIHCI

*incident. [...] This work was scheduled to be carried out in the period from November 2003 to February 2004*". This fact should have been taken properly into account when permitting a high current on this line.

As far as the San Bernardino line (Sils-Soazza) is concerned, the problem raised above is even more dramatic. Indeed, the temperature of the conductor reached 103°C just before it tripped, far above the maximum temperature which is constantly permitted on this line: 80°C. The sag therefore reached 20,86 m, as compared with a maximum of 17,90 m under the design conditions.

On the basis of information provided by FIHCI [8] and real-time data provided by UCTE [12], there are strong doubts that the procedures for designing and maintaining the EHV lines in Switzerland are coherent with the operating practices of the integrated Swiss electricity companies. There is therefore strong suspicion that the Swiss transmission grids are operated above their design values and that this endangers the security of electricity supply.

## CHAPTER 2

### ANALYSIS OF PLANNED AND REAL OPERATION

#### **Outline**

- This chapter analyses the operation of the interconnected grids before (planning operation) and during the events (real time operation) which led to the separation of Italian peninsula from the UCTE network.
- At 03:00 on September 28<sup>th</sup>, although the state of the grid just before the first contingency was in line with the forecasts available to all TSOs members of the UCTE, the Swiss transmission grids were not N-1 secure. Indeed, the countermeasures described in the UCTE report could not be considered as acceptable countermeasures, in view of the applicable rules. Furthermore, no data available to the regulators provide evidence that the integrated Swiss electricity companies had properly carried out a security assessment of their grids and prepared efficient countermeasures in case of the loss of the Lukmanier line.
- Although the consequences of this contingency were easy to forecast, and a very similar contingency had severely endangered the security of the UCTE grid in 2000, the real time reaction of the integrated Swiss electricity companies reveals a lack of preparation. They lacked the minimum precautions and successively took many inappropriate operational decisions which contributed to a deterioration in the situation.
- RTE and GRTN's real time reactions were consistent with the UCTE rules and appropriate.
- Moreover, although the analysis by UCTE of a very similar contingency in 2000 had shown the importance of immediate and efficient communication among TSOs, the integrated Swiss electricity companies did not follow the agreed information procedure with GRTN and RTE.

## A. Day-ahead security assessment and operational planning

According to the UCTE rules [1], it is up to each TSO to assess and ensure that the interconnected system will remain in a secure state, in the event that any element of its network is lost. For this purpose, the TSOs notably have access to data on the neighbouring grids, which are posted on the DACF on a day-ahead basis by the corresponding TSOs. Following this security analysis, each TSO is required to report any leak or congestion on its grid to the other TSOs.

For the night of September 28<sup>th</sup>, according to RTE, GRTN and FIHCI, the DACF procedure was conducted normally. Each TSO was therefore in a position to run its own N-1 security analysis for its network, either by applying the schedules on the expected network status or by checking the schedules against a comparable previous network status. GRTN and RTE confirmed that their security assessment was successfully performed, but, as the integrated Swiss electricity companies refused to participate in CRE and AEEG's inquiry, it has not been possible to verify this in their respect. However, the UCTE interim report [12] considers that it was the case, as it does not mention any difficulty in this process and even seems to confirm that it was successfully performed when it states that *"the system was complying with the N-1 rule, ETRANS taking into account countermeasures available outside Switzerland"*. Furthermore, according to RTE and GRTN, no communication was delivered by ETRANS; according to the UCTE rules, this means that the integrated Swiss electricity companies had judged that the forecast power flows on their grids fulfilled the N-1 criterion.

However, the real time operations showed that, after the trip of the Lukmanier line, the integrated Swiss electricity companies did not succeed in restoring the Swiss system's security. This raises questions as to whether they effectively complied with the N-1 security criterion. Two main points must be examined in this respect:

- the impossibility of re-closing the Lukmanier line,
- the use of external resources to restore secure conditions.

### 2.A.1 Lukmanier line re-closure

One reason put forward by UCTE [12] and by SFOE [13], is that *"the operators did not succeed in reconnecting the line because an automatic device refused to switch the breakers, based on the criterion that the phase angle difference over the line exceeded 30°"*. Indeed, ETRANS then spent around 10 minutes in an unsuccessful attempt to re-close the line. They then decided to call the Italian operator GRTN to ask for the Italian import to be decreased by 300 MW.

Line re-closure after tripping is a standard procedure: it allows a tripped line to be put back in service in the event of a non-permanent fault. When a line is connected to the grid at one of its ends and opened at the other end, a phase lag appears between the two poles of the breaker (figure 2.1)

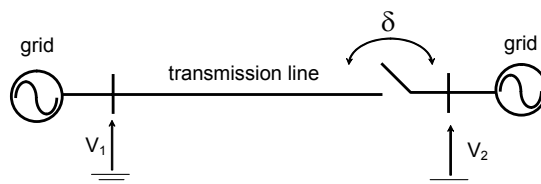

**Figure 2.1: opening a line makes a phase lag  $\delta$  appear between the line voltage and the grid voltage**



The re-closure of a line where the phase angle  $\delta$  is non-zero creates a transient which can be dangerous for the grid and for the generators: the higher  $\delta$  is, the more violent the transient. This is the reason why system operators do not allow the breaker to close if the phase angle  $\delta$  is greater than a given limit  $\delta_{lim}$ .

The value of  $30^\circ$  given by ETRANS is therefore not universal<sup>20</sup>. The setting of blocking devices preventing the automatic re-closure of tripped lines has to be based on an analysis of the network's topology and the location of generators. Knowledge of the setting procedure used by the integrated Swiss electricity companies could help to determine the actual severity of the situation after the Lukmanier line was tripped. It could also help provide a better picture of the appropriateness of the blocking procedure.

Furthermore, the permanent opening of the Mettlen – Lavorgo is an event that should have been considered in the integrated Swiss electricity companies' day-ahead security assessment. Corrective actions should therefore have been prepared to bring the system back to N-1 security levels, whilst the difficulties in re-closing the Lukmanier line should have been identified by the integrated Swiss electricity companies in their day-ahead security assessment.

#### 2.A.2 Use of external resources

Another reason put forward by UCTE [12] for the failure to restore system security after the incident on the Lukmanier line is that, in the case of this specific event, the integrated Swiss electricity companies needed *“as corrective measures which are necessary to comply with the N-1 rule, also action to be undertaken in the Italian system”*. Indeed, *“shutting down the pumps of the pumping storage plants in Italy was, from a technical point of view, the appropriate way of fulfilling the N-1 rule and restoring N-1 safety after the loss of the line”*[12]. The UCTE interim report further states that the measure taken by GRTN (in accordance with the request from ETRANS) after the loss of the Lukmanier line was *“clearly insufficient to return the system to a new N-1 state”*.

However, the UCTE rules state that *“the N-1 criterion may be kept with the support of a neighbouring system, subject to the prior agreement of the latter”* and the UCTE interim report further specifies that *“there is no official procedure or special agreement established between ETRANS and GRTN, apart from the operational practice (which was demonstrated in previous cases) to shut down the pumps in mutual support, when requested under emergency conditions by ETRANS”*.

According to the UCTE rules, shutting down the pumps in Italy can therefore not be considered as a countermeasure that can be taken into account in the N-1 security assessment of the interconnected transmission grids, unless there is evidence that it had previously been agreed with GRTN.

The integrated Swiss electricity companies were unable to provide evidence that they had designed efficient and available countermeasures for a contingency likely to be critical for the interconnected grids, which was predictable and whose consequences for the state of the interconnected grids were easy to estimate in advance. On the other hand, the events showed that either they did not implement such measures or the countermeasures were not efficient.

---

<sup>20</sup> E.g. in the case of RTE, the value of  $\delta_{lim}$  varies from  $20^\circ$  to  $60^\circ$  depending on the impedances of the network and the proximity of generators

For these reasons, it cannot be claimed that, before the Lukmanier line was tripped, the Swiss power system was N-1 secure.

### 2.A.3 Similarities between the contingencies of September 28<sup>th</sup>, 2003 and those of September 8<sup>th</sup>, 2000

During the night of September 8<sup>th</sup> – 9<sup>th</sup>, 2000 two successive incidents on the Lukmanier line (at 21:46) and on the San Bernardino line (25 minutes later, at 22:11) provoked a N-2 situation on the Swiss transmission grid [18]. These line trips led to overloads, particularly on lines from France to Italy, which reached their 20 minute overload protection threshold, or even their 10 minute overload protection threshold. Although the UCTE system was not prepared for such a N-2 contingency, the event did not lead to the separation of the Italian peninsula in the context of the night of September 8<sup>th</sup> – 9<sup>th</sup>, 2000. Indeed, the Italian TSO reacted in order to restore the security of the system without network separation: Italy increased its production by 1800 MW.

However, according to UCTE [17], *“it was not possible to implement a sufficiently rapid reduction of nearly 1500 MW in exchange programmes between Italy and Switzerland. For these reasons, the UCTE network frequency rose to 50,15 Hz”*. Furthermore, when the reduction of the exchange programmes could be agreed, from 24:00 onwards, it was, according to UCTE [17], *“firstly with France - who were able to react immediately – and subsequently with Switzerland, although reductions in exchange programmes with the latter were not sufficient to rectify the situation.”*

Although the grid situations were not identical, the similarity between the contingencies of September 28<sup>th</sup>, 2003 and those of September 8<sup>th</sup>, 2000 reinforces the conclusions of the previous analysis. In particular, it highlights the need to consider cautiously the consequences of the loss of the Lukmanier line in the integrated Swiss electricity companies’ security assessment and operational planning; this assessment should have meant that relevant corrective actions were prepared (an immediate reduction of exchanges on the Swiss-Italian border). It also stresses the importance of efficient communications between dispatchers in real time, in the event of a contingency. Accordingly, the UCTE 2000 annual report states that, as a result of the events, RTE, GRTN and the integrated Swiss electricity companies *“have agreed a joint procedure for the improvement of communications and the implementation of arrangements for the modification of exchange programmes in case of emergency”*.

There are strong similarities between the events which occurred in the night of September 8<sup>th</sup>, 2000 and the events which occurred in the night of September 28<sup>th</sup>, 2003.

The accidents occurred in the night of September 8<sup>th</sup>, 2000 had clearly demonstrated that the loss of the Lukmanier line could possibly induce within a very short time the loss of the San Bernardino lines. They had also demonstrated:

- the need to consider cautiously the consequences of the loss of the Lukmanier line in the security assessment and in the ability to react promptly to such a contingency by reducing the exchange programmes;
- the importance of efficient communications between system operators in real-time.

## **B. State of the interconnected grids at 03:00**

### 2.B.1 State of the Italian transmission grid

At 03:00 on September 28<sup>th</sup>, all transmission lines on the Italian transmission grid were in service, except for the following:

*Outages planned for maintenance purposes:*

- 380 kV Rondissone – Turbigio line
- 380 kV Candia – Rosara line
- 220 kV Soverzene – Scorzè line
- 220 kV Treviso Sud – Salgareda
- 200 kV line SA.CO.I. (Direct Current link with Corsica and Sardinia)

*Outages planned for operational purposes:*

- 380 kV Latina – Garigliano
- 380 kV Montalto – Suvereto 1
- 220 kV Avise – Villeneuve,
- 220 kV Lambrate – Porta Venezia
- 220 kV Magenta – Baggio,

All the above mentioned outages have been considered for the day ahead N-1 security assessment and operation planning.

### 2.B.2 State of the French transmission grid

At 03:00 on September 28<sup>th</sup>, all transmission lines of the French transmission grid were in service, except the following:

- Phase shifting transformer of La Praz, at the electrical border between France and Italy (maintenance works scheduled from August 30<sup>th</sup> to October 11<sup>th</sup>),
- 400 kV Chevalet-Gavrelle line (North of France)
- 400 kV Gaudière-Rueyres line (South-West of France)
- 400 kV Menuel-Tourbe (North-West of France)
- 400 kV Chesnoy-Tabarderie 1 line (Supply of Paris region)

All these outages had been previously reported to all TSOs of the UCTE, notably via the DACF. Furthermore, except for the phase shifting transformer of La Praz, they were all electrically very remote from the French-Italian electrical border and could therefore not significantly influence the flows in this part of the UCTE grid.

As far as the phase shifting transformer of La Praz is concerned, the maintenance work had been previously reported by RTE to GRTN and the Swiss integrated electricity companies. In any case, since its role is to balance the flows between the two 400 kV lines between Albertville and Rondissone and the 400 kV line between Venaus and Villarodin, it could not significantly contribute to restoring secure operation of the UCTE grid after the loss of the Lukmanier line.

As far as the French generation units are concerned, the only disconnection which occurred during the night of September 28<sup>th</sup> was Cruas 3's, which occurred at 22:53, for scheduled works. In any case, this unit is electrically very remote from the French-Italian electrical border.

### 2.B.3 State of the Swiss transmission grids

No information was made available to AEEG and CRE by the integrated Swiss electricity companies.

### 2.B.4 Commercial cross border transactions

The commercial transactions relating to imports into Italy for the time period between 03:00 and 04:00 on September 28<sup>th</sup> are shown in the table 2.1.

	France	Switzerland	Austria	Slovenia	Total
<b>Allocable capacity</b>					
Summer NTC (from May to September)	2400	2500	200	300	5400
Non firm capacity	0	0	0	100	100
<i>Total Summer</i>	<i>2400</i>	<i>2500</i>	<i>200</i>	<i>400</i>	<i>5500</i>
<b>Winter NTC (from October to March)</b>					
Winter NTC (from October to March)	2650	3050	220	380	6300
Non firm capacity	0	0	0	100	100
<i>Total Winter</i>	<i>2650</i>	<i>3050</i>	<i>220</i>	<i>480</i>	<i>6400</i>
<b>Commercial nominations September 28th, 2003</b>					
<i>yearly rights</i>	<i>2409</i>	<i>3050</i>	<i>220</i>	<i>365</i>	<i>6044</i>
<i>daily allocated (September 27th, 2003)</i>	<i>238</i>	<i>0</i>	<i>0</i>	<i>0</i>	<i>238</i>
<i>energy exchange recovery – losses provision (TSOs agreements)</i>	<i>3</i>	<i>-7</i>	<i>3</i>	<i>2</i>	<i>1</i>
<i>Spot allocation</i>	<i>0</i>	<i>15</i>	<i>0</i>	<i>0</i>	<i>15</i>
<i>Non firm capacity</i>	<i>0</i>	<i>0</i>	<i>0</i>	<i>100</i>	<i>100</i>
<b>Planned commercial exchanges</b>	<b>2650</b>	<b>3058</b>	<b>223</b>	<b>467</b>	<b>6398</b>

Table 2.1 – Planned commercial exchanges for the night of September 28<sup>th</sup>, 2003 (made available by GRTN)

Compared with the agreed NTCs (see § 1.6), there is therefore an excess import of 8 MW on the Swiss electrical border due to a spot allocation carried out by GRTN and the integrated Swiss electricity companies deriving from the daily allocation of capacities on the border between Italy and Switzerland<sup>21</sup>. However, the amount of capacity concerned is too small to have had a significant influence on the events which led to the separation of the Italian peninsula.

### 2.B.5 Physical and commercial flows

To assess the state of interconnected grids, it is sometimes suggested that physical flows at the interconnections should be compared with commercial transactions. This approach is for example used by SFOE in its *Report on the blackout in Italy on 28 September 2003* [13]. SFOE justifies the choice of this approach by the following statement: “Any major and systematic discrepancies

<sup>21</sup> Daily allocation procedures are in force on the other borders.

*between capacity-related export quotas and actual cross-border flows based on commercial transactions, interfere with secure operation on neighbouring networks.”*

Actually, the physical flows on the interconnected grids result from the network topology and from the distribution of generation and loads, which notably depends on scheduled commercial flows. More precisely, the power flows in the lines of a meshed grid are defined by the laws of physics. As a first approximation, power flows can be roughly estimated by proportional share rules based on line impedances. Taking into account the complexity of the actual grid topology, and also considering the fact that two power flows in opposite directions cancel each other out, it is therefore almost impossible to determine power flows in a simple and intuitive way merely on the basis of power injections and loads.

The complex algorithm which allows the system operators to predetermine actual flows from the knowledge of both the topology and the injections and loads is known as “power flow” (PF) computation. This calculation is totally deterministic. It can be carried out with the help of computer programs which allow the operator to ensure that load forecasts and injection forecasts are compatible with the structure of the grid and with the physical constraints due to line capacities and security assessment. Such a power flow computation always reveals unavoidable differences between commercial programs between countries or zones and physical flows.

Let us consider a very simple study case (figure 2.2), involving three interconnected countries (A, B and C). Impedances on frontier lines are supposed to be purely inductive and the values of impedances are set arbitrarily.

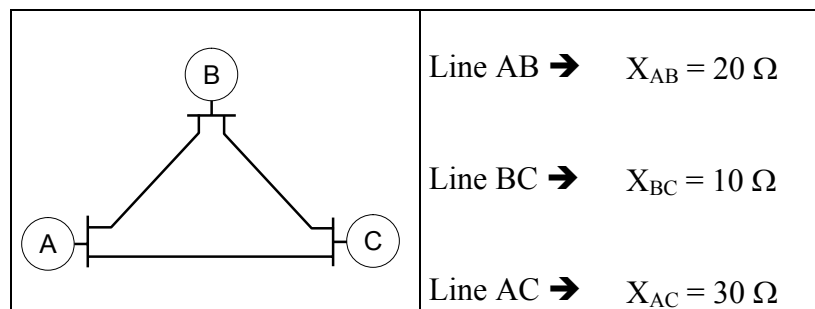

Figure 2.2 : a very simple « meshed » network interconnecting three countries A, B and C

Let us assume that countries A and B export energy towards country C, according to the following scheduled programmes:

from ...	to ...	scheduled exchange
A	C	$P_{AC} = 2000 \text{ MW}$
B	C	$P_{BC} = 3000 \text{ MW}$

Power flows can be evaluated following a proportional rule based on line impedances and assuming that power flows due to various exchanges can be superposed. This simplified approach is based on a rough hypothesis: the network is supposed to be linear for power flows, no losses are taken into account and only active power flows are considered. This set of assumptions is often known as “DC approximation”. Even if results are approximated, they are representative of reality.

Figure 2.3 shows the power flows obtained when taking into account only the exchange A→C, only the exchange B→C and both exchanges.

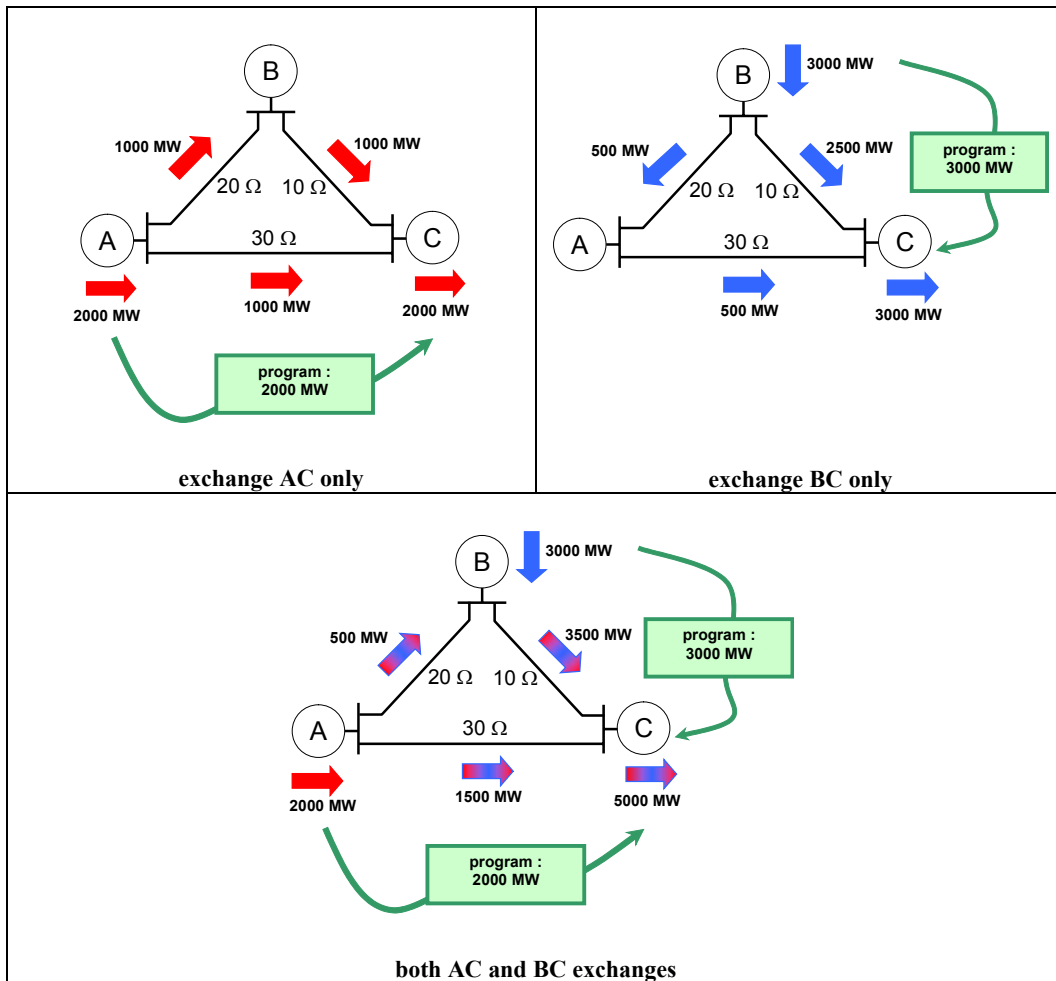

Figure 2.3 : examples of physical flows on a « meshed » network

The very simple case described above clearly shows that commercial programmes and physical flows cannot match, except in very specific cases which would be a matter of coincidence. The only solution to ensure that physical frontier flows and commercial programs match perfectly is to un-mesh the network. In our simple example, the solution is to open line AB. But in that case, the exchanges of power must be strongly limited and the security of the interconnected grid, which relies heavily on its meshed status, is strongly reduced.

Therefore, it does not make sense to try to match frontier power flows with commercial programmes in an interconnected system. That would require control over power injections which is incompatible with an open market, or would even mean un-meshing the network.

Differences between physical flows in the interconnection lines and commercial exchanges between countries are unavoidable in a meshed network. They are not the product of a failure in grid operation or in commercial practices; they are due to physical laws.

Such differences cannot be classified as unexpected line overloads: branch flows can be easily predicted by load flow computations. It is the responsibility of the system operator to take into account scheduled programmes during security assessment.

It is necessary that system operators exchange more data, with the aim of better taking into account commercial programmes in security assessment studies.

## C. Real time operation

### 2.C.1 Coherence of the status of the Italian power system with the forecast scenario for the night of September 28<sup>th</sup>

To evaluate whether the conditions of operation were secure before the loss of the Lukmanier line, under the condition that all security assessment and day-ahead operation planning had been properly carried out, the actual state of the interconnected grid in real time has to be compared with the forecast scenarios. As the Swiss integrated electricity companies refused to participate in CRE and AEEG's enquiry, the only available forecast scenario concerning the Swiss-Italian interconnection is the forecast of the status of the Italian power system at 03:00:00. delivered by GRTN to CRE and AEEG. There is no substantial difference (see table 2.2) between the status of the Italian power system at 03:00:00 on September 28<sup>th</sup> and the situation forecast on a day-ahead basis by GRTN.

	<i>Scheduled situation h 03:30 (MW)</i>	<i>Actual situation h 03:00 (MW)</i>	<i>Difference (MW)</i>	<i>Difference %</i>
<b>Data relevant to electric energy consumption</b>				
Load + losses	23.240	23.930	690	+3.0
Pumps	3.288	3.487	199	+6.1
States of San Marino and Città del Vaticano	27	27	0	0
<b>Total supply</b>	<b>26.555</b>	<b>27.444</b>	<b>889</b>	<b>+3.3</b>
<b>Data relevant to electric energy production</b>				
Thermal power plants	18.231	18.721	490	+2.7
Hydro power plants	1.051	1.182	131	+12.5
Geothermal power plants	580	551	-29	-5.0
Wind mills	10	10	0	0
<b>Total production</b>	<b>19.872</b>	<b>20.464</b>	<b>592</b>	<b>+3.0</b>
<b>Data relevant to electric energy import</b>				
Import from the North border	6.398	6.678	280	+4.4
Import from Greece	285	300	15	+5.3
<b>Total Italian import</b>	<b>6.683</b>	<b>6.978</b>	<b>295</b>	<b>+4.4</b>
			<b>0</b>	
<b>Total electrical energy injected into the Italian power system</b>	<b>26.555</b>	<b>27.442</b>	<b>887</b>	<b>+3.3</b>

Table 2.2 – Balance of electric power in the Italian system at 03:00 (provided by GRTN)

Table 2.2 shows a load exceeding the schedule of about 890 MW (about 200 MW of which are due to pumping) balanced by a higher level of Italian generation (about 590 MW) and import (about 300 MW).

### 2.C.2 Coherence of Italian import with GRTN's forecast scenario for the night of September 28<sup>th</sup>

The difference of 280 MW in scheduled and actual imports from the Northern border is a normal deviation, below the TRM (500 MW). Indeed, as it is demonstrated in § 1.7, instantaneous differences between physical flows in the interconnection lines and scheduled exchanges between countries are unavoidable. They are not the product of a failure in grid operation or in commercial practices. They are due to the laws of physics.

To compare the instantaneous conditions of the interconnection with the forecast scenario, AEEG and CRE chose the highest level of total import (measured at time 03:01:24) in the two hours before the first trip, which is assumed to be the most unfavourable situation. The results obtained for any other point in time between 01:00:00 and the time at which the Lukmanier line was first tripped, lead to the same conclusions. The figures for the situation at 03:01:24, provided by GRTN, are shown in table 2.3<sup>22</sup>.

	From	To	Rated voltage (kV)	Maximum current limit (A)	h. 03:00	P (MW)	V (kV)	Var. %	I (A)	% of I <sub>max</sub>
France	Villarodin	Venaus	380	1637	Operating	684	396,0	4,2%	1009	62%
	Albertville	Rondissone	380	2370	Operating	772	398,9	5,0%	1128	48%
	Albertville	Rondissone	380	2370	Operating	680	398,9	5,0%	989	42%
	BrocCarros	Camporosso	220	917	Operating	198	236,5	7,5%	487	53%
Switzerland	Lavorgo	Musignano	380	2270	Operating	1292	392,4	3,3%	1983	87%
	Soazza	Bulciago	380	2300	Operating	1108	399,5	5,1%	1655	72%
	Riddes	Avisse	220	1010	Operating	254	237,5	8,0%	618	61%
	Riddes	Valpelline	220	1010	Operating	278	237,2	7,8%	677	67%
	Airolo	Ponte	220	900	Operating	221	232,5	5,7%	550	61%
	Morel	Pallanzeno	220	900	Operating	131	232,0	5,5%	328	36%
	Robbia	Sondrio	220	900	Operating	223	228,6	3,9%	567	63%
	Gorduno	Mese	220	900	Operating	144	220,0	0,0%	378	42%
Austria	Lienz	Soverzene	220	800	Operating	198	228,7	4,0%	502	63%
Slovenia	Divaccia	Redipuglia	380	2880	Operating	580	404,9	6,6%	827	29%
	Divaccia	Padriciano	220	960	Operating	96	233,2	6,0%	239	25%

Table 2.3 – North border situation at 03:01:24 (GRTN data)

Table 2.3 shows that:

- all the interconnection lines were in operation, as forecast on a day-ahead basis;
- all the voltages were within their operating limits ( $\pm 10\%$  of the rated values);
- all the currents were much lower than their maximum limits;
- the deviation of the real time operation from the scheduled import did not result in any breach of technical constraints, as expected, as the total import was actually under the TTC level (6900 MW), agreed by TSOs.

However, table 2.4 shows that, compared to the forecast situation, there was an excess import of 491 MW: the instantaneous extra import, which was below the TRM of 500 MW, was essentially imported through the French and Slovenian borders. As far as the Swiss border is concerned, the physical flows were very close to the forecast. Moreover, in the two hours before the first trip, the power imported from Switzerland peaked at 3653 MW, lower than the forecast (3686 MW).

<sup>22</sup> These instantaneous values, corresponding to the maximum peak of import lasting only a few seconds, were chosen to adopt (for the comparison) the worst condition, despite being of little significance for the line conductor temperature (which depends on previous power transits over a much longer period of time).



	DACF scenario 03:30 (MW)	Time 03:01:24 (MW)	Difference (MW)	Difference %
France	1996	2334	338	16.9%
Switzerland	3686	3651	-35	-0.9%
Austria	258	198	-60	-23.3%
Slovenia	428	676	248	57.9%
<i>Total</i>	<i>6368</i>	<i>6859</i>	<i>491</i>	<i>7.7%</i>

**Table 2.4 – Comparison of forecasts and physical flows at 03:01:24 (GRTN data)**

Although it had no direct impact on physical flows on the Swiss border, the excess import of up to 491 MW must be questioned. As mentioned in Chapter 1, exchanges of power between countries are controlled by the f/p regulation system that automatically tends to maintain the exchanges on average at the planned value. During the night of September 28<sup>th</sup>, the predetermined fixed exchange (set point of f/p regulation) was set, for the Northern border (excluding exchanges with Greece), at the commercial value of 6398 MW, constant throughout the night, according to total commercial nominations.

However, the analysis of the time behaviour of the total import on the Northern border of Italy shows a variation that was unavoidable due to normal real-time operations of interconnected power systems. Figure 2.4 shows the instantaneous deviations of the power imported from the set point of the f/p regulation (6398 MW) from 01.00.12 to 03:25.12. The curve shows a mean value almost equal to zero: the average power imported from the foreign countries was 6368 MW, almost equal (actually slightly lower) to the set point. The mean value of the imports into Italy during a longer period was therefore equal to the programmed exchange. This confirms the efficiency of secondary regulation on the Italian borders in the night of September 2003 and that devices were set appropriately. It also shows that the maximum excess import of 491 MW resulted from normal fluctuations of cross border flows in an interconnected transmission grid.

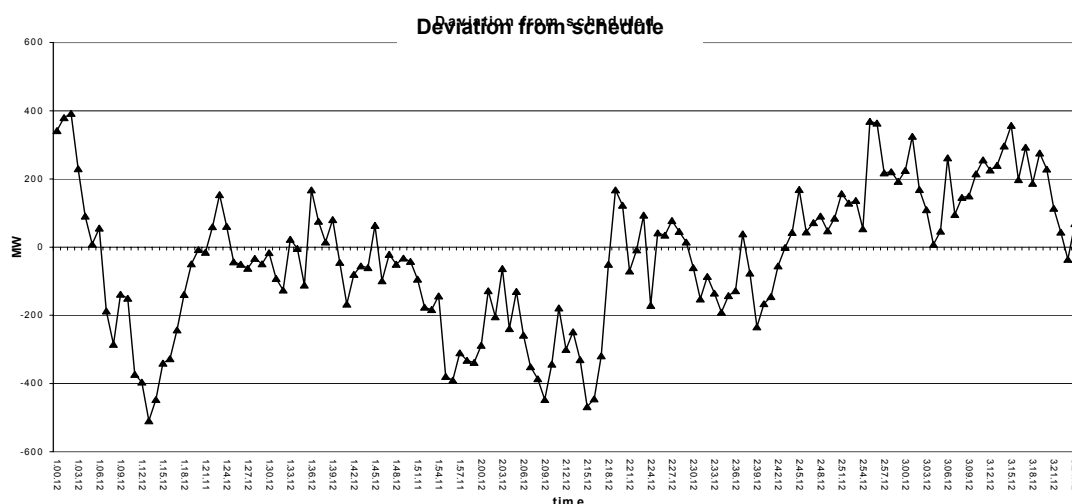

**Figure 2.4 – Deviation from the f/p set point scheduled (GRTN data)**

Moreover, figures 2.5 and 2.6 show the oscillatory behaviour for each border: it can be seen that the oscillation effect is more marked on the Slovenian border than on other borders.

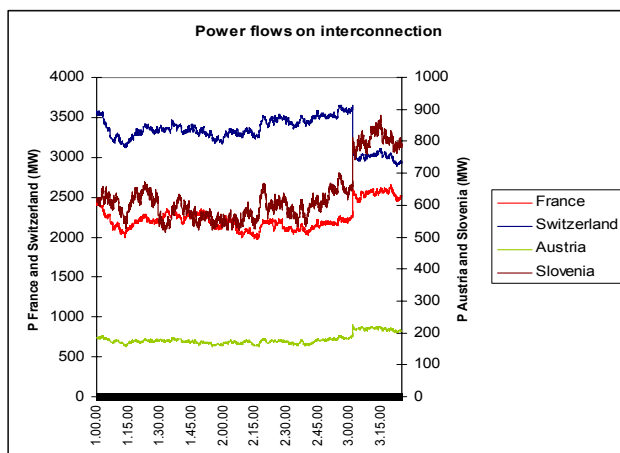

Figure 2.5

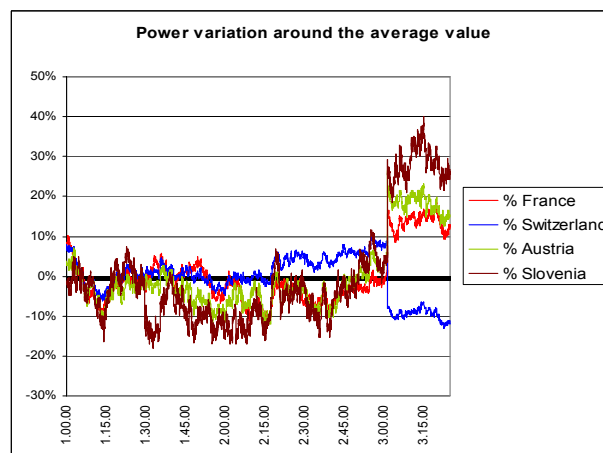

Figure 2.6

The state of the interconnected system at 03:00 was in line with forecasts.

The instantaneous extra-import on the Northern Italian border (around 300 MW) cannot be claimed as the root cause of the overload of the San Bernardino line. In fact, differences between the sum of actual power flows in the interconnection lines of a country and the sum of scheduled power exchanges can often reach values up to 300 MW and even much higher, positive or negative, instantaneously or as an average over several minutes, due to the time constants of secondary frequency control.

### 2.C.3 Real time reactions of GRTN and RTE after the loss of the Lukmanier line (first trip)

Following the loss of the Lukmanier line, fluctuations could be observed in flows on the cross border lines and on the GRTN and RTE's grids. As, according to GRTN, these fluctuations observed did not induce any breach of the N-1 security conditions on its grid, GRTN did not take any operation action, until ETRANS asked for a reduction of 300 MW in imports into Italy. In response to this request, GRTN increased production in Italy by 270 MW and reduced consumption by 155 MW, by taking the following actions :

- production increase in Torrevaldaliga Nord (Central Italy) from 280 MW to 350 MW (70 MW increase);
- production increase in Montalto di Castro (Central Italy) from 400 MW to 500 MW (100 MW increase);
- production increase in Rossano Calabro (Southern Italy) of 100 MW;
- storage pump reduction in Entracque (North-Western Italy) of 155 MW;

The total impact on imports was a reduction of 425 MW, which is 125 MW more than actually requested by ETRANS.

As far as RTE is concerned, it detected that the fluctuations observed induced an overload on its grid in case of the loss of the Albertville – Grande-Île 400 kV line. It therefore followed its operation procedures for such an event: in order to control transits after an eventual loss of the Albertville – Grande-Île 400 kV line, in spite of the increase in flows on this line, at 3:02 it ordered an increase in production by the generation units of Brévières and Malgovert. This redispatching was effective between 03:05 and 03:10. It also modified the topology at the La Saussaz 225 kV substation in order to avoid local constraints on the French 225, 90 and 63 kV network in case of

the loss of the Albertville – Coche 400 kV line. This topology operation (opening the feeder to the line Longefan – Vieux-Moulin) was completed at 03:11.

According to the UCTE rules, it was up to the integrated Swiss electricity companies to take actions in order to restore the secure operation of the interconnected transmission grids.

On their side, RTE and GRTN had to verify that their grids could deal with the loss of any element, considering the actual flows after the Lukmanier line trip.

#### 2.C.4. Restoring secure operation after the loss of the Lukmanier line (first trip)

The Lukmanier line trip occurred on the Swiss transmission grid. According to the UCTE rules and the tri-lateral procedure, it was therefore up to the Swiss integrated electricity companies to react and restore the system's security.

The only countermeasure planned for that contingency, according to UCTE [12], was the shedding of pumps in Italy. However, according to UCTE [12], the Swiss operator spent 9 minutes in unsuccessful attempts to re-close the Lukmanier line. It therefore did not follow its internal procedure, as described by UCTE [12]. Moreover, the aforementioned countermeasure (pump shedding) is not a proper countermeasure because it is not in the Swiss power system and had not previously been agreed with GRTN. Furthermore, this reaction was inappropriate as the Swiss operator should have already known beforehand that it would be impossible to re-close this line, and taken this into account.

On the contrary, in the absence of any prior agreement from GRTN to change the programme of its pumps, the integrated Swiss electricity companies should, as a precaution, have modified power production in Switzerland in order to suppress the overload in an efficient way. This measure should have been implemented temporarily until the Lukmanier line was re-closed or until a significant change in the Italian load (pumping) or production had been implemented, as a result of dialogue between ETRANS and GRTN. Since the integrated Swiss electricity companies refused to co-operate in the regulators' inquiry, there has been no way of examining whether such a wise measure could in fact have been taken. It must be noted that in the Swiss context, since ETRANS does not have direct control over the topology of the Atel and EGL grids, as opposed to GRTN and RTE for their own national systems, it is not obvious that such a measure could have been taken.

After 9 minutes, according to UCTE [12], the Swiss operator came to the conclusion that the re-closure was impossible because of a phase angle greater than 30°. In this new situation, the San Bernardino line was overloaded. Power flows on the Swiss network had to be reduced. For this purpose, two solutions were available:

- the first was a temporary modification of the flows in order to let the phase angle decrease from 42° to 30°, making re-closure possible. This is the method recommended by UCTE rules (see paragraph 1.3);
- the second solution involved decreasing the power flow through Switzerland.

Later, according to UCTE [12] and SFOE [13], the integrated Swiss electricity companies asked GRTN to decrease Italian imports by 300 MW in order to return to the scheduled exchange programmes. This action was not in line with their internal procedure, as described by UCTE [12]. Indeed, GRTN was only asked to decrease the power exchange on the Northern border by 300 MW and not to stop pumping. It was also inappropriate since, as the later facts demonstrate, although

GRTN implemented the requested import reduction, the integrated Swiss electricity companies were unable to re-close the Lukmanier line or to alleviate the San Bernardino line overload. Indeed, following the laws of physics, the GRTN's reduction of the overall import by 300 MW was spread across all the interconnections. Therefore, only a small part of the 300 MW actually contributed to reducing the load on the San Bernardino line. Figures 2.8 and 2.9 show that, despite the 300 MW overall import reduction implemented by GRTN, the reduction through the Swiss border was very low.

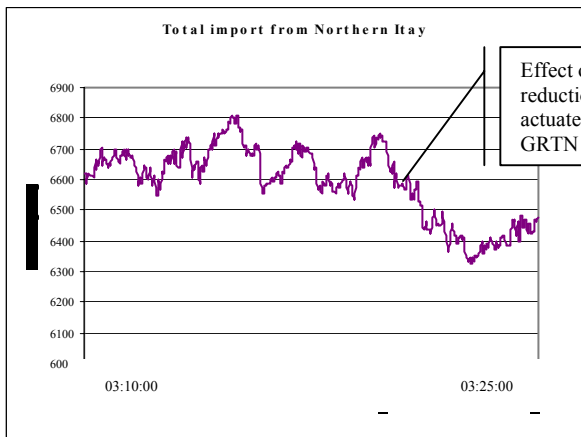

Figure 2.8

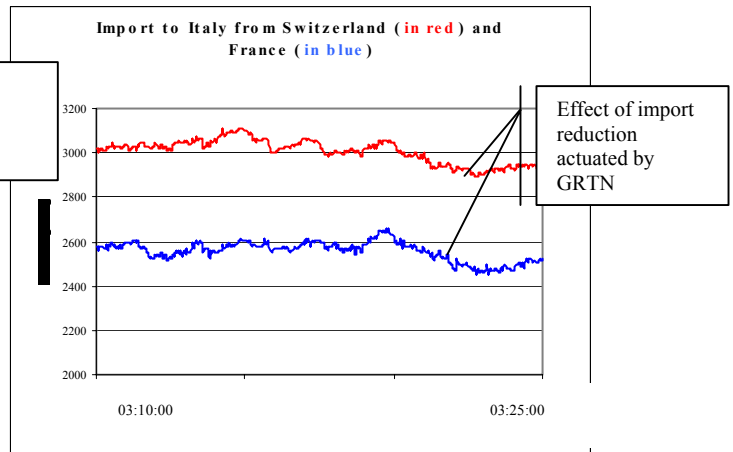

Figure 2.9

The countermeasure ordered by the integrated Swiss electricity companies was therefore not sufficient to relieve the overload on the San Bernardino line.

Following the actions taken by GRTN, given the evident low incidence of such measures in relieving overload on Swiss grid, ETRANS did not communicate anything to GRTN.

After the Lukmanier line trip, the integrated Swiss electricity companies took a number of inappropriate operational decisions:

- for 9 minutes, they attempted to re-close a line which could not be re-closed, as could have been anticipated through simple day-ahead calculations,
- they then implemented countermeasures which were not capable of restoring system security,
- they only asked for reduction of 300 MW of Italian total import and relied on corrective measures outside their area which had not been previously agreed (pumps shedding),
- they did not follow their internal procedure, as published by UCTE [12].

#### 2.C.5. Real-time compliance with the UCTE rules and the tri-lateral procedure

The analysis of the sequence of events, as described by UCTE [12], RTE and GRTN shows that:

- ETRANS did not inform either RTE or GRTN by fax within an acceptable period. In fact, according to UCTE [12], the first fax was sent to the GRTN at 04:34, more than 1 ½ hours after the first fault on the Lukmanier line. The first fax was sent to RTE at 06:29, almost 3 ½ hours after the first fault;
- ETRANS did not report the situation to GRTN until 9 minutes after the first line trip (request of power exchange total reduction of 300 MW).

The emergency procedure defined in 2001 between RTE, GRTN and ETRANS was not applied by ETRANS.

The integrated Swiss electricity companies reported the situation of their grids to the neighbouring operators in a time which was not compatible with the need to urgently implement corrective measures outside their system, in order to restore secure operation of the interconnected grids.

#### **D. Separation of the Italian power system from the UCTE network**

At 03:21:00, imports into the Italian system were reduced by 300 MW. However, this control measure was not sufficient to mitigate the overload of the San-Bernardino line, which tripped at 03:25:22, or of the 220 kV Mettlen-Airolo line, which tripped 3 seconds later. Shortly afterward, other 220 kV lines internal to the Swiss system tripped and the southern part of Switzerland (Ticino canton) was separated from the remaining part of the Swiss grid. At that point, this region was then supplied by the Italian system. The remaining lines from Riddes and Robbia to Italy then also tripped, thus overloading the interconnection with France. This overloading caused a significant and rapid voltage decrease (at some French busses, voltages reached 300 kV). The combination of low voltages and high currents caused the French 380 kV Albertville-La Coche–Praz line to trip at 03:25:32.

This trip was followed by the loss of synchronisation on the Italian system, which resulted, 2 seconds later, in the separation of Italy from France (trip of the 380 kV double circuit Albertville-Rondissone and of other 220 kV lines). Immediately, 220 kV Soverzene-Lienz line and the 380 kV link with Slovenia also tripped. The Italian system remained asynchronously connected to the UCTE grid only via a 220 kV line and a local 132 kV linking grid to Slovenia, until 03:26:24. At that time, the disconnection was complete.

## **CHAPTER 3**

### **RECOMMENDATIONS**

On the base of the analysis carried out by AEEG and CRE, the following main recommendations can be outlined.

1. UCTE rules shall be made more detailed.
2. Compliance with UCTE rules shall be made legally binding.
3. It shall be enforced an independent assessment and control of UCTE rules.
4. Co-ordination among TSOs shall be reinforced for operational planning and real time operation of the interconnected grids.
5. A legal and regulatory framework coherent with EU legislation should be enforced in all European continental plate to ensure the security of grid operation and supply in Europe.

## CHAPTER 4 APPENDIX

### **4.1 Sequence of Network Events which Occurred on September 28<sup>th</sup>**

The list of events along with the information exchanged during the events is provided in the following table.

	<b>Event</b>	<b>Source</b>
03:01	Trip of the 380 kV line Mettlen Lavorgo (CH). Attempts to re-close the line until 3.03:50 automatically. Also manual re-closure fails at 3:03:50.	UCTE Interim Report, SFOE Report
03:02-3:08	Attempts to re-close the Mettlen - Lavorgo line. Information exchanges between ETRANS and ATEL and EGL dispatchers.	SFOE Report
03:10	ETRANS, by phone, requests a reduction of 300 MW in Italian imports to scheduled values <sup>23</sup> .	SFOE Report
03:18-3:22	Exchange of information between ETRANS, ATEL and EGL and changes in topology of the Swiss system.	UCTE Interim Report
03:21	Italian imports are reduced to 6400 MW	SFOE Report
03:25	Trip of the Sils-Soazza 380 kV line (CH)	UCTE Interim Report, SFOE Report
03:25	Trip of the Airolo Mettlen 220 kV line (CH)	UCTE Interim Report, SFOE Report
03:25	Cascading effect: trip of all the interconnection lines from Italy to the remaining part of the UCTE system	UCTE Interim Report

<sup>23</sup> The contents of the phone call could not be clearly established.

## 4.2 Source of data

### *Publicly available data*

- [1] Summary of the current operating principles of the UCPTE, 1998
- [2] Measures to counteract major disruptions in interconnected operation and to re-establish normal operating conditions, UCPTE, 1991
- [3] Ground rules concerning primary and secondary control of frequency and active power within the UCPTE, UCPTE, 1998
- [4] Net Transfer Capacity NTC: ETRANS: <http://www.etrans.ch/index/?cid=0x102>
- [5] Net Transfer Capacity NTC : GRTN applications for capacity allocations on Northern border for the year 2003 : <http://www.grtn.it>
- [6] Net Transfer Capacity NTC : RTE publication: [http://www.rte-france.com/htm/fr/offre/offre\\_inter\\_attrib.htm](http://www.rte-france.com/htm/fr/offre/offre_inter_attrib.htm)
- [7] Net Transfer Capacity NTC: Verbund publication: <http://www.verbund.at/at/apg/netzinfo/netzdaten/engpass.pdf>
- [8] Report of the Federal Inspectorate for Heavy Current Installations on the event of 28 September 2003 available at <http://www.energie-schweiz.ch/imperia/md/content/energiemrkteertgertechniken/elektrizitt/strompanne03/12.pdf>
- [9] R.Bacher, D.Reichelt: “Applications areas of optimisation techniques to power systems”. CIGRE Task Force 38-34-02/03 – February 1996.
- [10] North American Reliability Council: “Available Transfer capability definitions and determination”. Technical Report NERC, June 1996, available on <http://www.nerc.com>.
- [11] H.J.C.Pinto, M.V.F. Pereira, M.J.Teixeira: “New parallel algorithms for the security-constrained dispatch with post-contingency corrective actions”. X Power System Computation Conference, Graz (Austria), Aug.1990.
- [12] UCTE Interim Report of the Investigation Committee on the 28 September 2003 Blackout in Italy available at <http://www.ucte.org/pdf/Publications/2003/UCTE-IC-InterimReport-20031027.zip>
- [13] SFOE, “Report on the blackout in Italy on 28 September 2003”, November 2003, available at <http://www.energie-schweiz.ch/imperia/md/content/energiemrkteertgertechniken/elektrizitt/strompanne03/4.pdf>
- [14] U.S.-Canada power system outage task force: “Interim report: Causes of the August 14th blackout in the United States and Canada”, November 2003. Available on <https://reports.energy.gov/>
- [15] NERC operating manual, February 10, 2004, available on <http://www.nerc.com/>
- [16] Reliability standards and system operating practices in Nordel, Nordel, 2002. Available on <http://www.norde1.org>
- [17] UCTE 2000 annual report (pages 65 and 67 on the events of September 8th, 2000) available at : [http://www.ucte.org/pdf/Publications/2000/Report\\_2000.pdf](http://www.ucte.org/pdf/Publications/2000/Report_2000.pdf)
- [18] Gestion des interconnexions électriques en Europe, article by Hervé Laffaye et al. in Techniques de l’Ingénieur, 2-3003
- [19] Security constrained OPF for optimal scheduling in an open access environment, article by A.Berizzi, G.Demartini, M.Delfanti, P.Marannino, G.Rizzi in 13 Power Systems Computation Conference, Trondheim (Norway), June 28-July 2, 1999, pp.1214-1219.

*Among the private data made available to AEEG and CRE by GRTN and RTE as requested, the following documents are mentioned in the present report:*

- [20] Procédure d’urgence Suisse-Italie-France, a common procedure established by RTE, GRTN and ETRANS on 25/6/2001
- [21] GRTN document on Oct.22th, 2002 to AEEG and Ministry of productive activities relevant to the agreed TTC and NTC figures for the year 2003
- [22] UCTE State of the art of the DACF procedure